

# FDQ125C

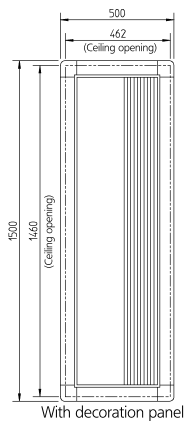
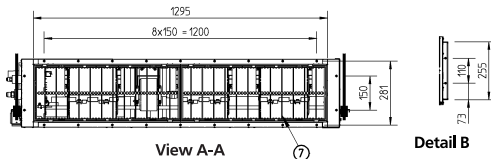
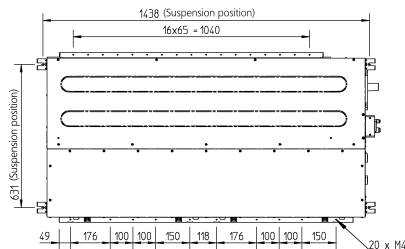
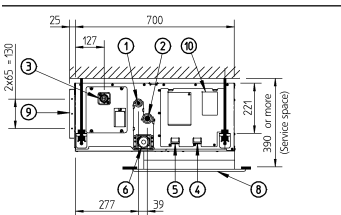
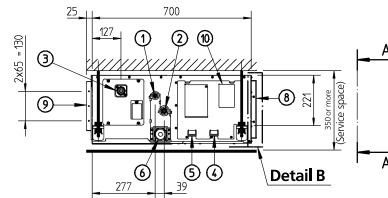
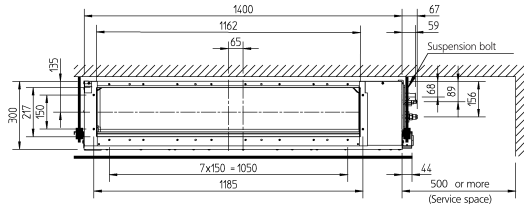
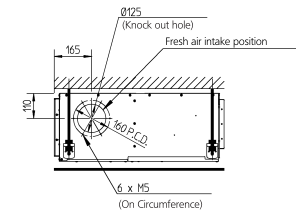

Item	Name	Description
1	Liquid pipe connection	φ 8.53 Flare connection
2	Gas pipe connection	φ 15.90 Flare connection
3	Drain pipe connection	VP25 (LD, φ 32, LD, φ 25)
4	Remote controller wiring connection	-
5	Power supply connection	-
6	Drain hole	VP25 (LD, φ 32, LD, φ 25)
7	Air filter	-
8	Air suction side	-
9	Air discharge side	-
10	Nameplate	-

## NOTES

- 1 Refer to the outlook drawing of optional accessories when installing them.
- 2 The required ceiling depth varies according to the configuration of the specific system.
- 3 For maintenance of the air filter, it is necessary to provide a service access panel.
- 4 Optional decoration panel: BYBS125DJW1 (Light ivory white 10Y9/0,5)

# FDQ200-250B

unit (mm)

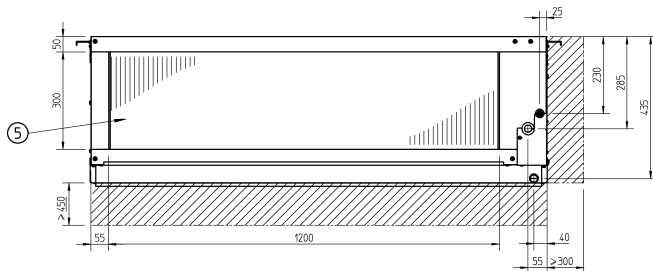

View A

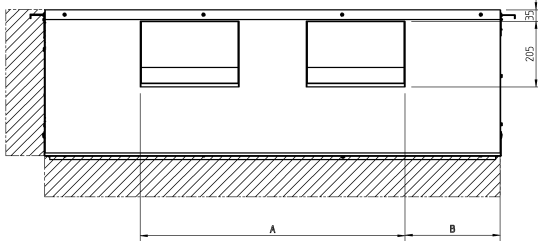

- ① Power supply intake
- ② Drain connection  $\phi$  25 O.D.
- ③ Gas pipe connection  
FDYP200B/250B : 1 1/8" O.D. or 28,6 mm  
FDQ200/250 : 7/8" O.D. or 22,2 mm O.D.
- ④ Liquid pipe connection  
FDYP200B : Single union joint 1/2" or 12,7mm  
FDYP250B : Single union joint 5/8" or 15,9mm  
FDQ200 : Single union joint 3/8" or 9,52 mm  
FDQ250 : Single union joint 1/2" or 12,7mm
- ⑤ Filter

Notes:

 : Service space

Model	A	B
FDYP200B8V19/FDQ200B8V3B9	830	285
FDYP250B8V19/FDQ250B8V3B9	890	255

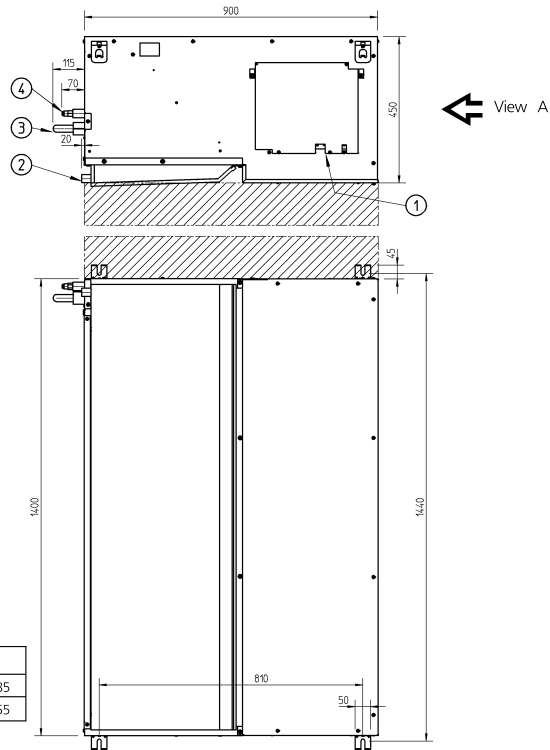

View A